

BEIJING HUADE HYDRAULIC INDUSTRIAL GROUP CO.,LTD.	Pressure relief valves,type DB3U			RE 25825/12.2004
	Size 10 to 30	up to 31.5 MPa	up to 600 L/min	Replaces; RE25825/05.2001

Features:

- Subplate mounting
- Threaded connection
- Installation in manifolds
- 3 adjustment elements:
 - Rotary knob
 - Screw with internal hexagon and protective cap
 - Rotary knob with scale
- Solenoid operated control via mounted directional valve



Functional description, section

Types DB3U pressure valves are pilot operated pressure relief valves.

They are used for the limitation of the operating pressure, and they may be switched over to different(2 or 3 pressure stage)by solenoids actuated.

The pressure relief valves consist mainly of the main valve, 4/3,4/1-Directional control valve(Type WE5...)and three pilot valves.

In the de-energised condition the pressure in port A is set by pilot valve(7).

The pressure present in port A acts on the main spool(1). At the same time pressure is applied via the control lines (12) and (4),which are fitted with orifices (2) and (3),on the spring loaded side of the main spool(1) and at the poppet(6) in the pilot control valve (7).If the pressure in port A exceeds the value set at the spring (8),the poppet (6) opens against the spring (8).

The signal for this comes internally via the control lines (12) and (4) from port A.The pressure fluid on the spring loaded side of the main spool(1) now flows via the control line (3),poppet (6) into the spring chamber(9).In type DB3U...30/...it flows internally via the control line (10) to tank,or in type DB3U..30/..Y..externally via the port Y. Due to the orifices (2) and (3) a pressure drop occurs at the main spool(1),the connection from port A to port B is open. Now the pressure fluid flows from port A to port B while maintaining the valve set operating pressure.

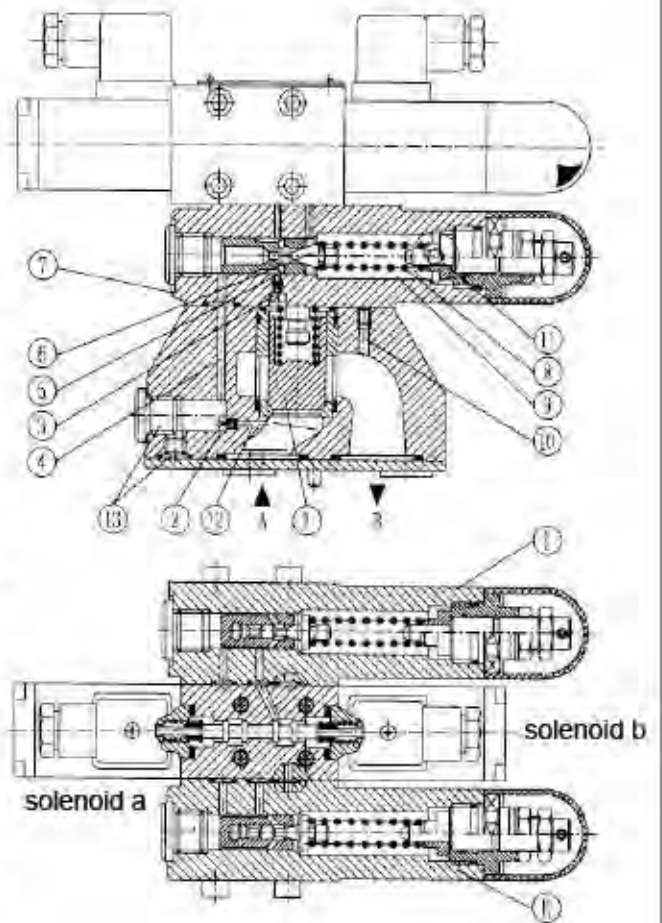

Symbols

No Code

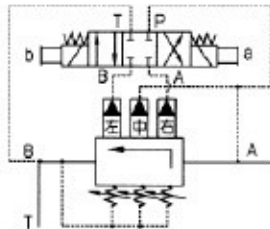

DB3U...E.../...

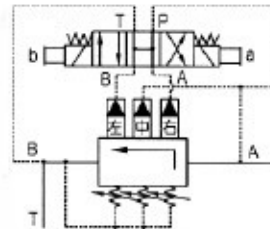

DB3U...H.../...

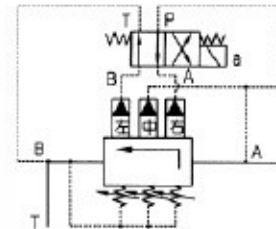

DB3U...N.../...

Model "X"

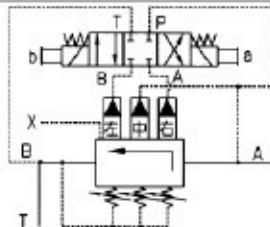

DB3U...E.../...X

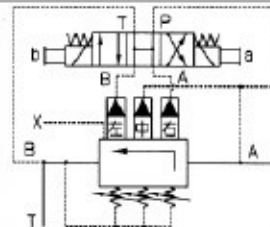

DB3U...H.../...X

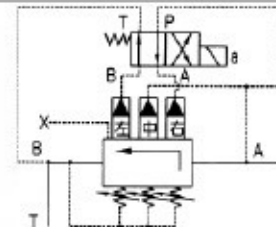

DB3U...N.../...X

Model "Y"

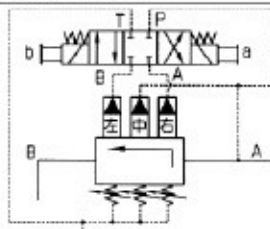

DB3U...E.../...Y

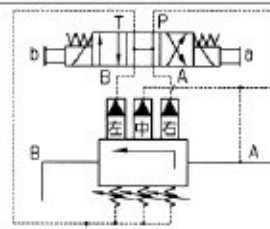

DB3U...H.../...Y

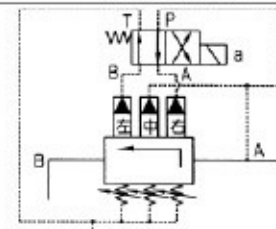

DB3U...N.../...Y

Model "XY"

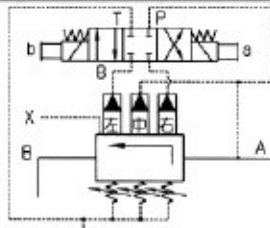

DB3U...E.../...XY

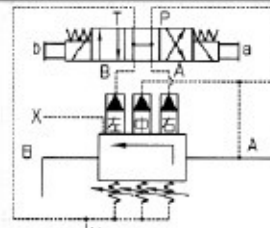

DB3U...H.../...XY

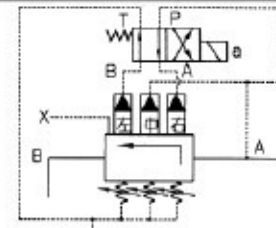

DB3U...N.../...XY

Technical data

Size		8	10	15	20	25	30
Flow (L/min)	Threaded connection	100	200		400		600
	Subplate mounting	-	200	-	400	-	600
Operating pressure	(MPa)	ports A, B, X, up to 31.5					
Back pressure (port Y)	(MPa)	up to 31.5					
Min. Setting pressure	(MPa)	see operating curves					
Max. Setting pressure	(MPa)	up to 10 or 31.5					
Pressure fluid		Mineral oil (for NBR seal) or phosphate ester (for FPM seal)					
Viscosity range	(mm ² /s)	10 to 800					
Temperature range	(°C)	-30 to +80					
Size of directional valve		see directional valve 4WE5					

Operating Curves (measured at $v = 41 \text{ mm}^2/\text{s}$ and $t = 50 \text{ }^\circ\text{C}$)

The operating curves were measured with an external pilot oil, zero pressure return.

With internal pilot oil return the input pressure is increased by the output pressure present at port B.

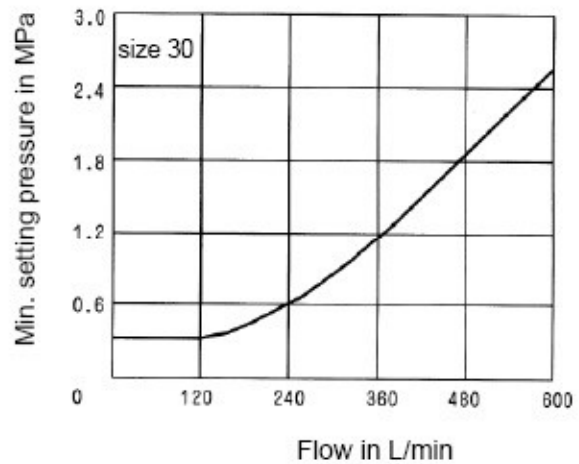
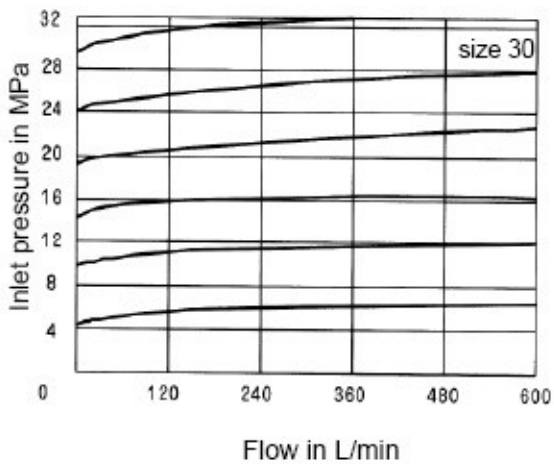
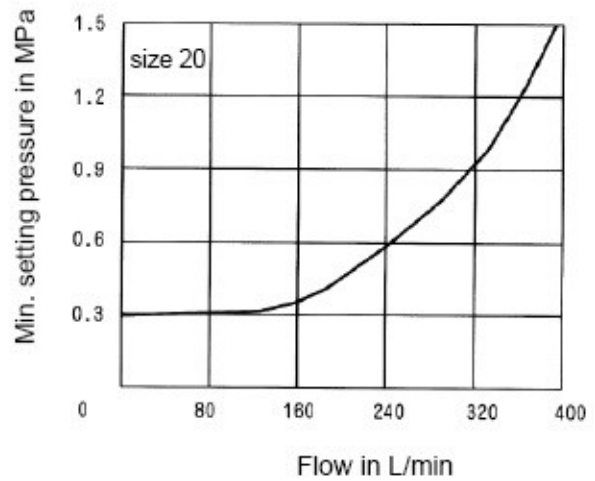
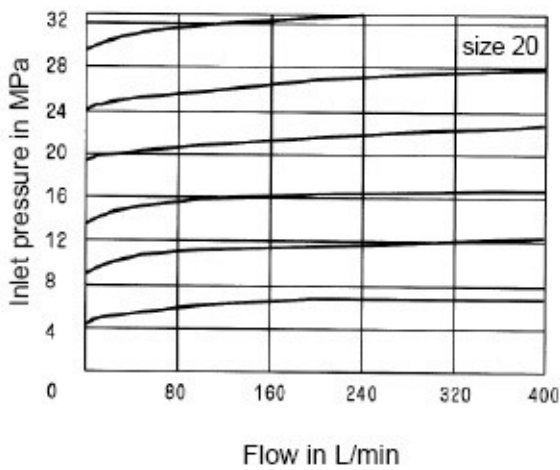
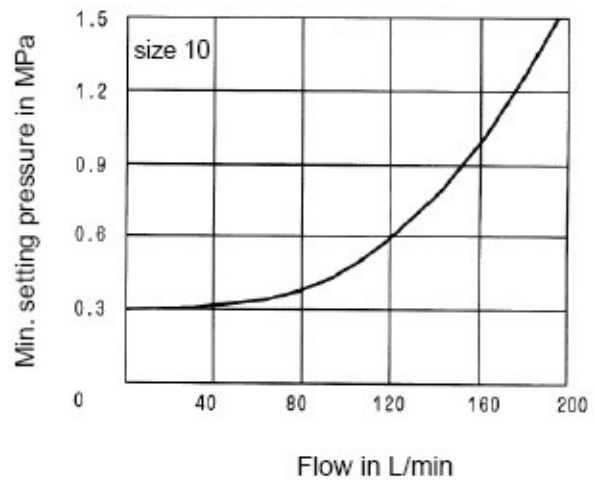
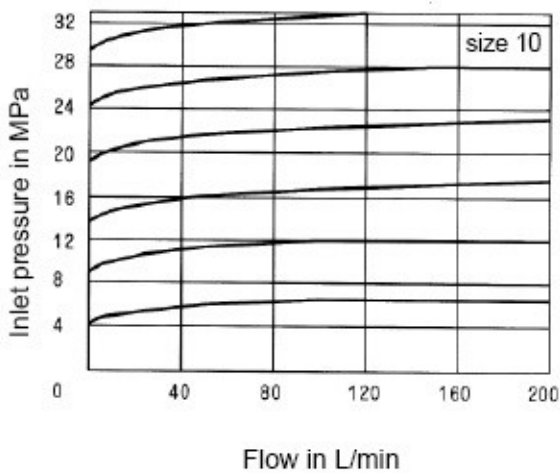

Unit dimensions: For subplate mounting

(Dimensions in mm)

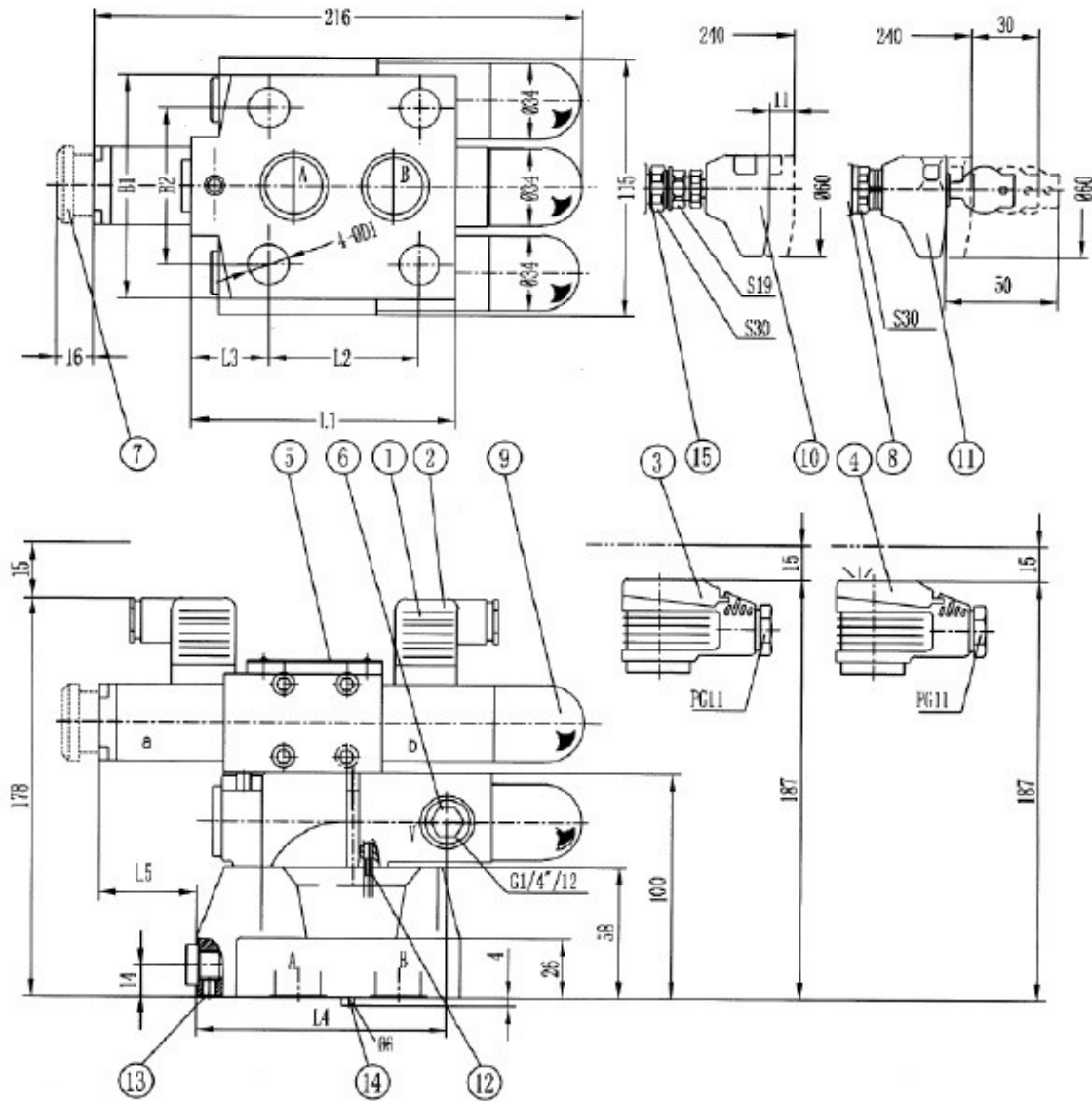

Subplate: see page 149

G545/01 G545/02

G546/01 G546/02(NG10)

G408/01 G408/02

G409/01 G409/02(NG20)

G410/01 (G1/4 ")G410/02

G411/01 (M14X1.5)G411/02

1 Plug-in connector " Z4 "

2 Plug-in connector: color gray

3 Large plug-in connector " Z5 "

4 Large plug-in connector with light
" Z5L "

5 Nameplate

6 Port Y for external pilot oil drain

7 Hand override, optional

8 repeat adjusting scale

9 Adjustment element 1

10 Adjustment element 2

11 Adjustment element 3

12 inside pilot oil drain is not need

13 Port X for pilot oil drain

14 Locating pin

15 only apply to up to 31.5MPa

NG	D1	B1	B2	L1	L2	L3	L4	L5	Weight	Port X, O-ring	Ports A, B, O-ring
10	14	78	54	90	54	23.5	97.5	59.5	7.8kg	9.25 × 1.78	17.12 × 2.62
20	18	100	69.8	117	66.7	34	111	46	8.5Kg	9.25 × 1.78	28.17 × 3.53
30	20	115	82.5	148	89	41.5	121	36	9.8Kg	9.25 × 1.78	34.52 × 3.53

DB3U unit dimensions of ports

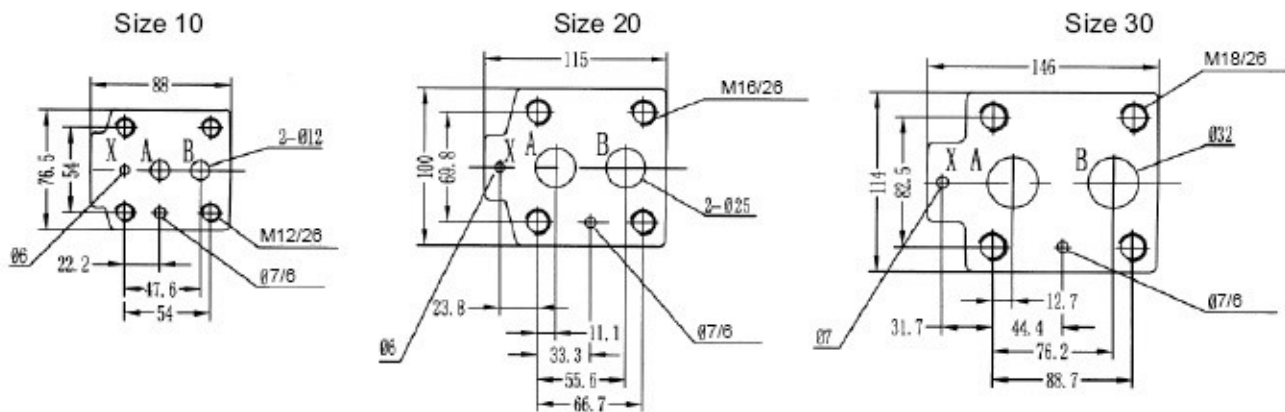

Remote control valve DBT2U, unit dimensions:

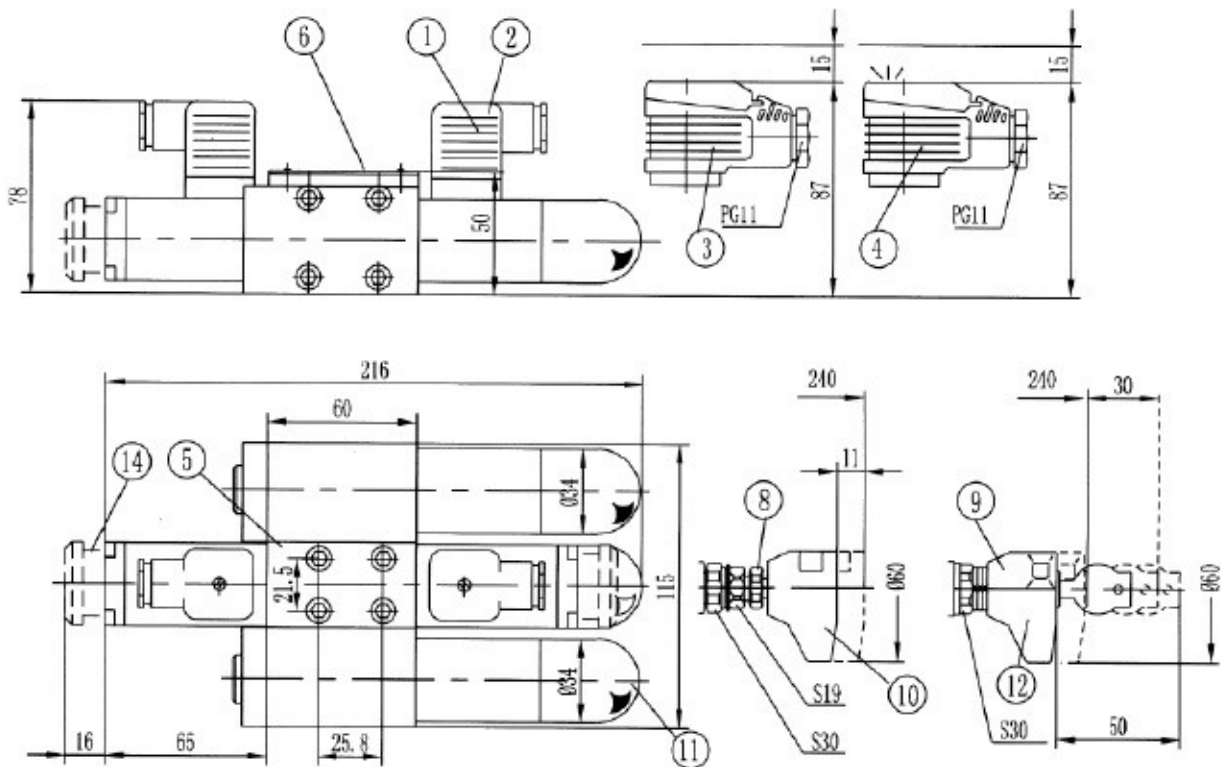

- | | | |
|---|--------------------------------|--------------|
| 1. Plu-in connector "Z4" | 6. Nameplate | Subplate: |
| 2. Plug-in connector: colour gray | 8. Only apply to up to 31.5MPa | G51/01 |
| 3. Large plug-in connector "Z5" | 9. Repeat adjusting scale | G51/02 |
| 4. Large plug-in connector with light "Z5L" | 10. Adjustment element 1 | see page 148 |
| 5 Directional valves, type WE5 | 11. Adjustment element 2 | |
| | 12. Adjustment element 3 | |
| | 14. Hand override optional | |

Unit dimensions: Threaded connection

(Dimensions in mm)

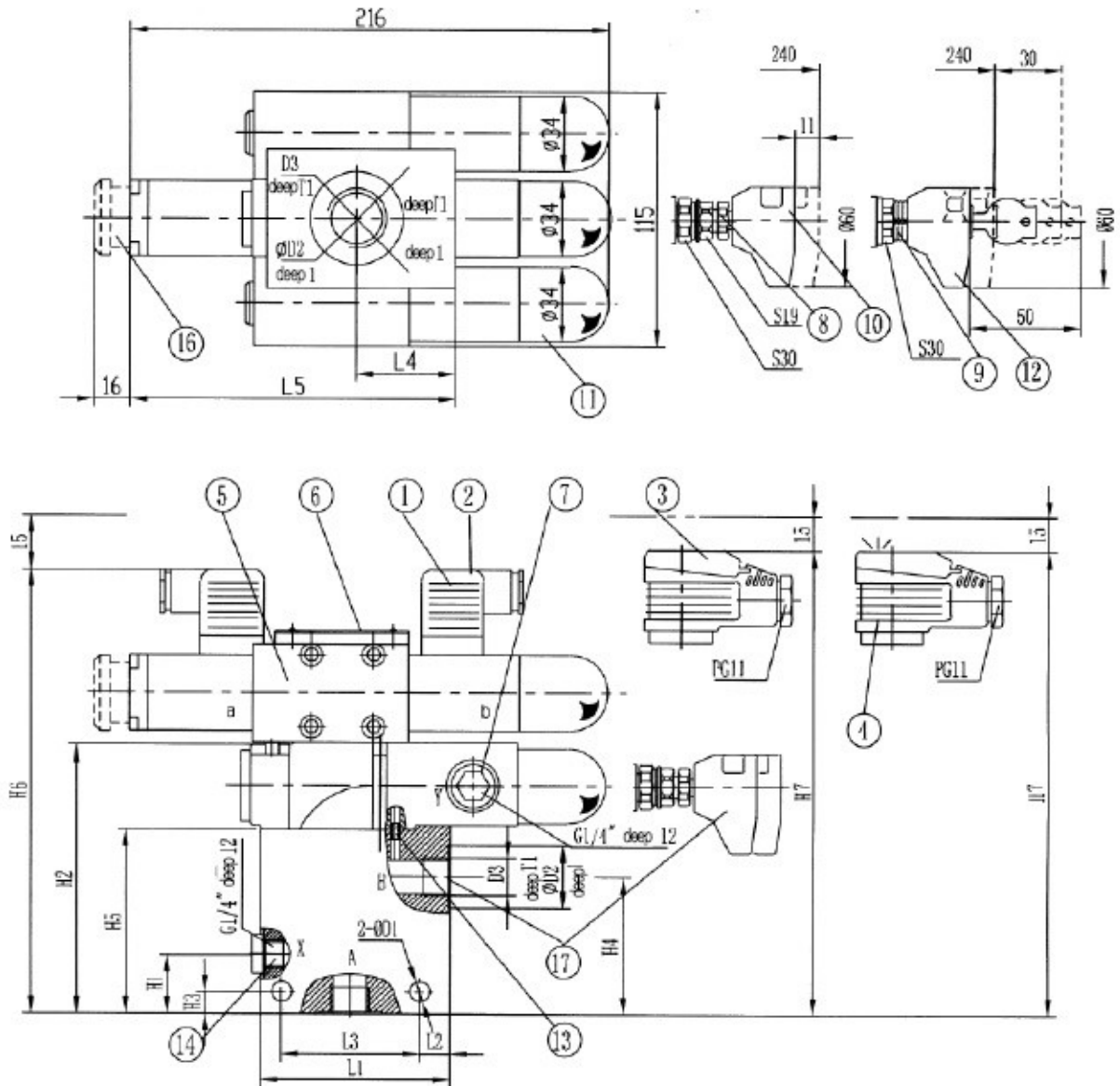

- | | | |
|--|--|---|
| 1. Plug-in connector without circuitry | 7. Port Y for external pilot oil drain | 13. When internal pilot oil drain, is not need |
| 2. Plug-in connector: colour gray | 8. Only apply to up to 31.5MPa | 14. Pilot oil drain X |
| 3. Large plug-in connector | 9. Repeat adjusting scale | 16. Hand override, optional |
| 4. Large plug-in connector with light | 10. Adjustment element 1 | 17. When use adjustment element 1 or 3, connect with B, must need right angle elbow |
| 5. Directional valves, type WE5 | 11. Adjustment element 2 | |
| 6. Nameplate | 12. Adjustment element 3 | |

NC	B1	ϕ D1	ϕ D2	D3	H1	H2	H3	H4	H5	H6	H7	L1	L2	L3	L4	L5	L6	T1	Weight(Kg)
8	63	9	28	G3/8"(M18 × 1.5)	27	125	10	62	85	203	212	85	14	62	45	146	10	12	8.5
10			34	G1/2"(M22 × 1.5)														14	8.5
15			42	G3/4"(M27 × 2)														16	8.7
20			47	G1"(M33 × 2)														18	8.7
25	70	11	56	G1 1/4"(M42 × 2)	42	138	13	66	98	216	225	100	18	72	54	155	1	20	9.4
30			61	G1 1/2"(M48 × 2)														22	9.4

Unit dimensions: for cartridge connection

(Dimensions in mm)

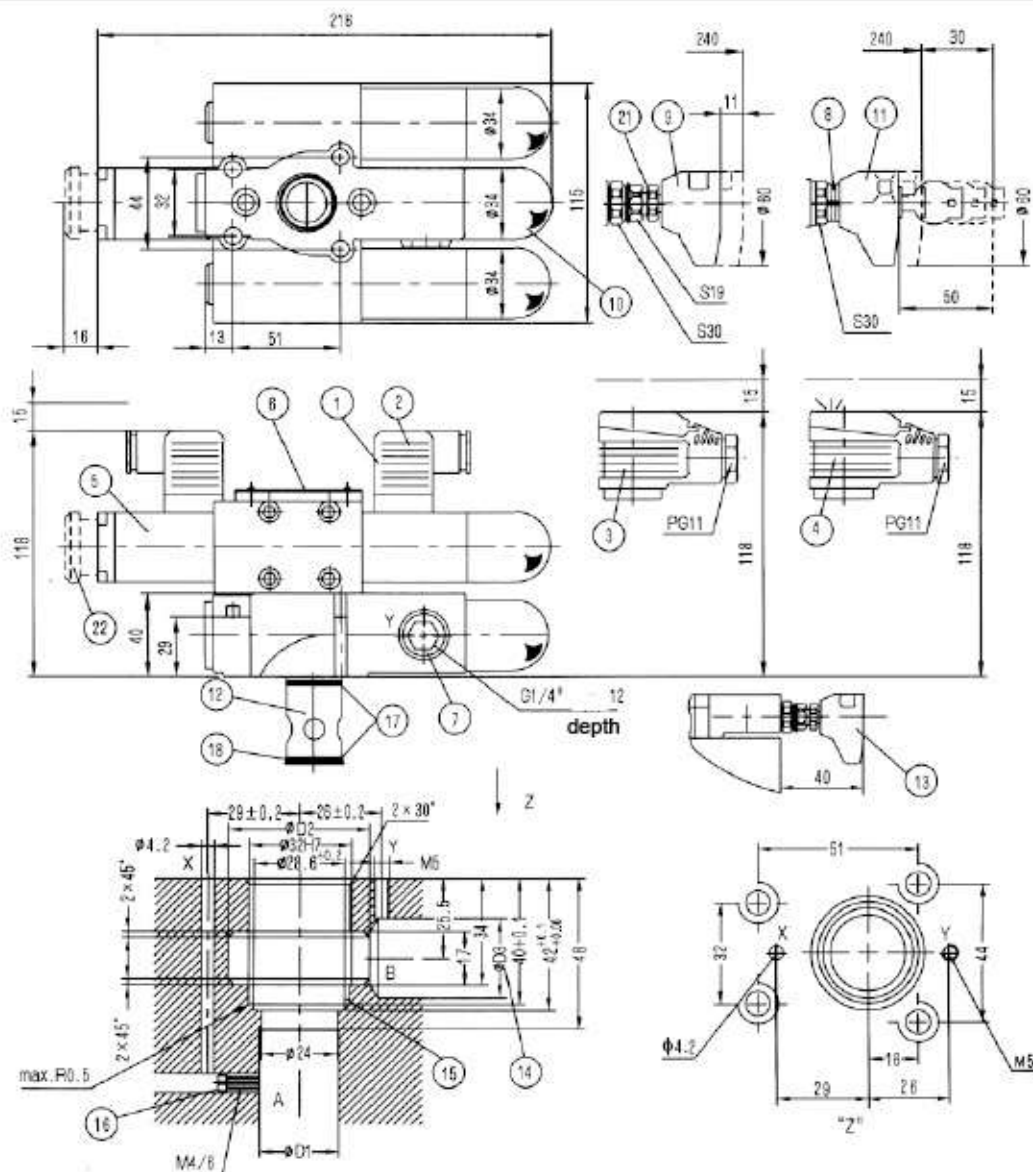

- | | | |
|---|------------------------------------|--|
| 1. Plug-in connector "Z4" | 10. Adjustment element 2 | and the fixing screw holes do not intersect. |
| 2. Plug-in connector: colour gray | 11. Adjustment element 3 | 15. Back-up ring and O-ring must be fitted |
| 3. Large plug-in connector "Z5" | 12. Main spool assembly | into the main bore before assembling |
| 4. Large plug-in connector with light "Z5L" | 13. Min. distance when use adjust- | the main spool. |
| 5. Directional valves, type WE5 | ment element 1 or 3 fixing the | 16. Orifice |
| 6. Nameplate | integration block | 17. O-ring 27.3X2.4 |
| 7. Port Y for external pilot oil drain | 14. The D3 bore may enter the D2 | 18. Retainer ring 32x28.4x0.8 |
| 8. Repeat adjusting scale | bore at any position. However, | 21. Only apply to 31.5 MPa |
| 9. Adjustment element 1 | care must be taken that X port | 22. Hand override, optional |

NC	ϕ D1	ϕ D2	ϕ D3	Weight DB3UC	Fixing screw (GB/T70.1-2000)	Torque
10	10	40	10	6 Kg	4-M8 \times 40 -10.9	31
20	25	50	25			
30	32		32			